

# 6C-MINI

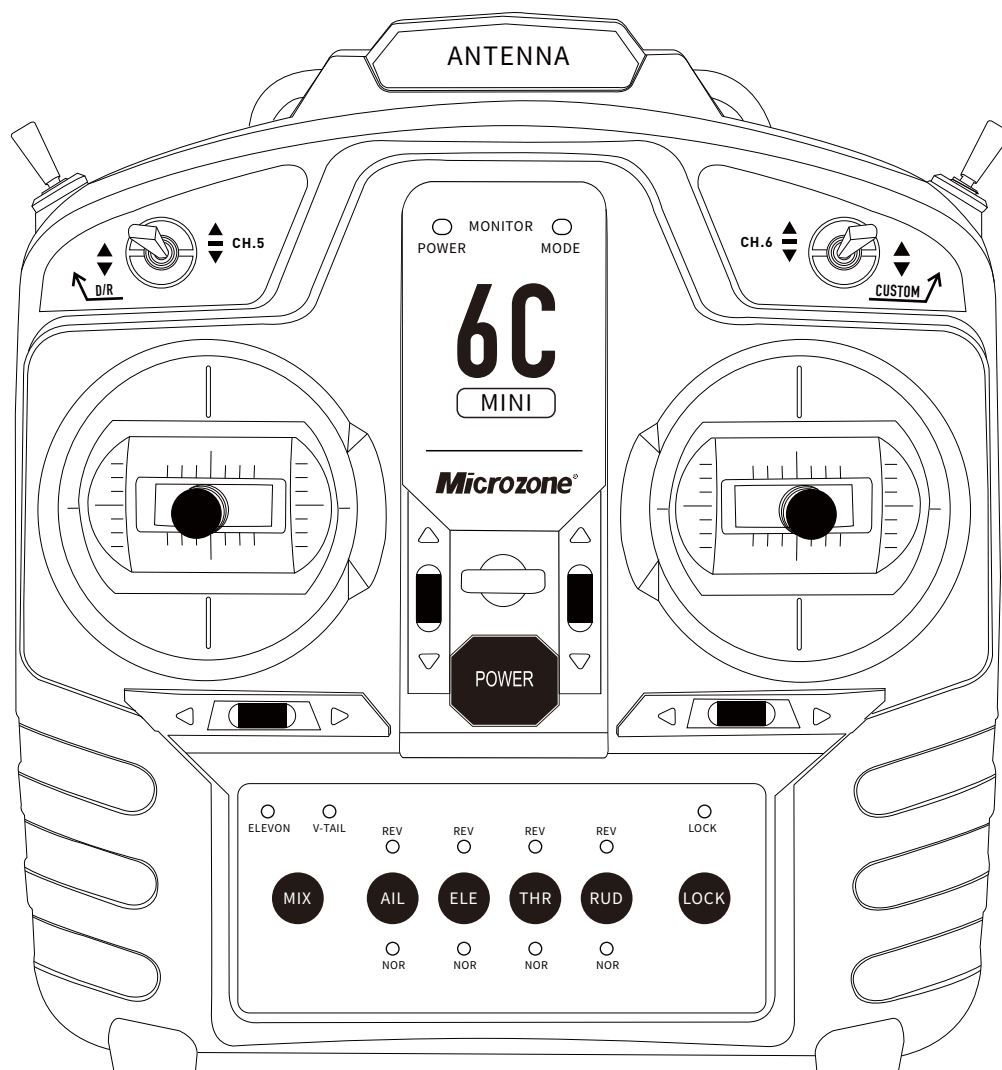

## PRODUCT MANUAL

Please read the instruction manual before use

## REMOTE CONTROL FUNCTION ANALYSIS

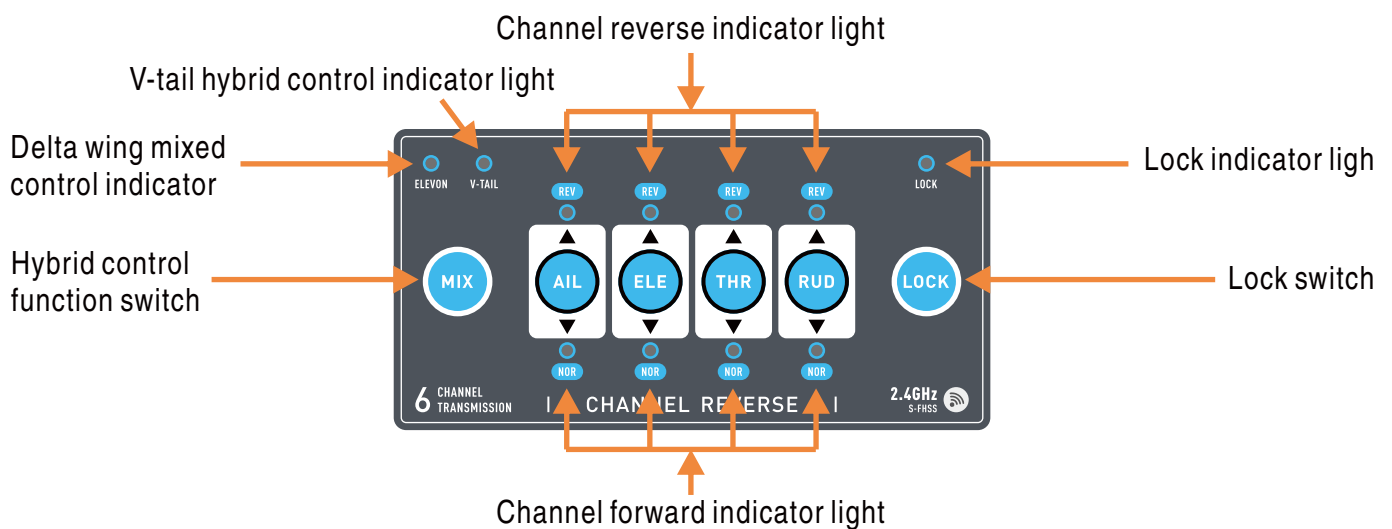
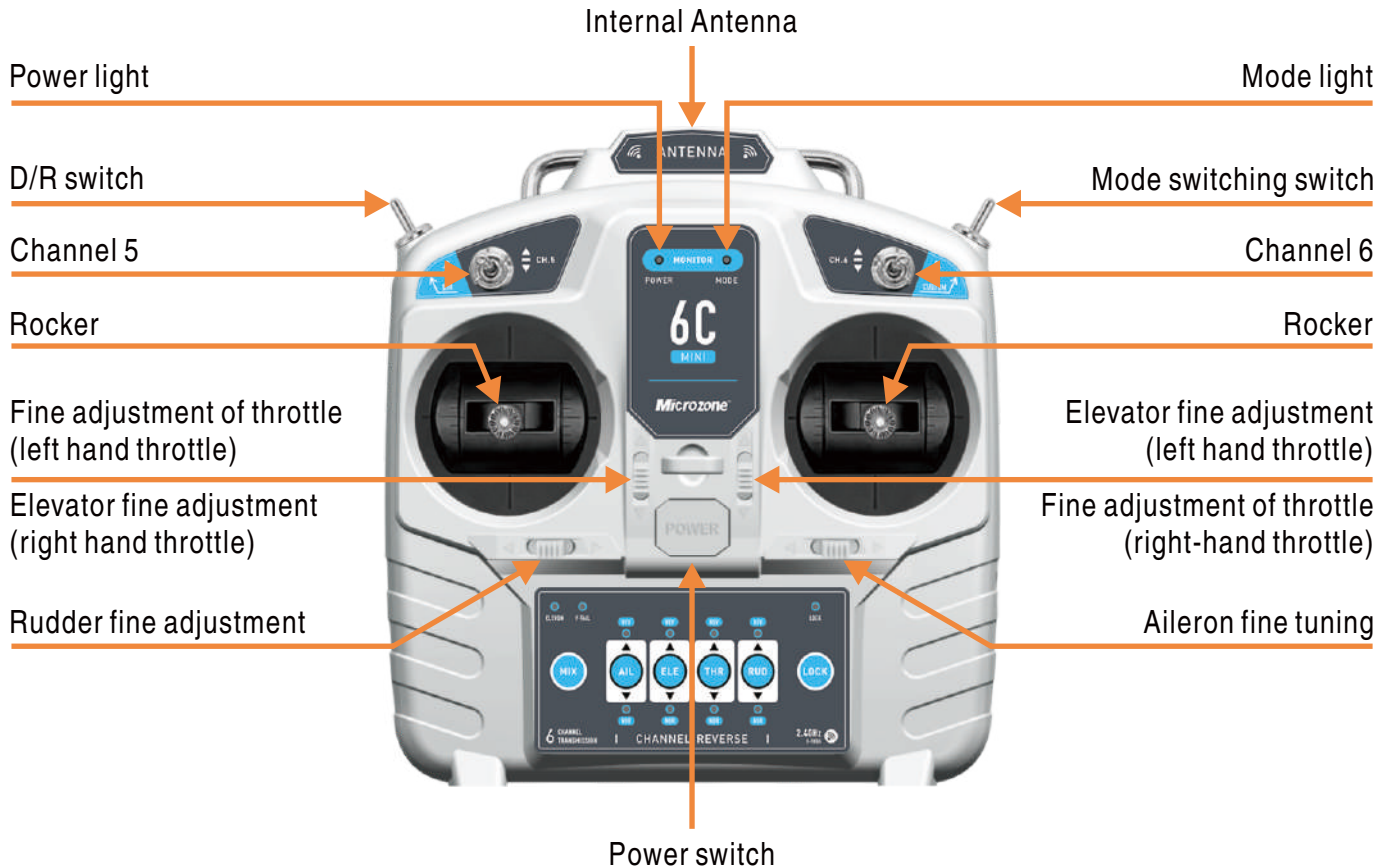

**AIL:**Aileron channel front and back settings CH.1

**ELE:**Front and back settings of the lifting channel CH.2

**THR:**Throttle channel positive and negative settings CH.3

**RUD:**Direction channel front and back settings CH.4



## RECEIVER FUNCTION ANALYSIS

### MC6RE-V2

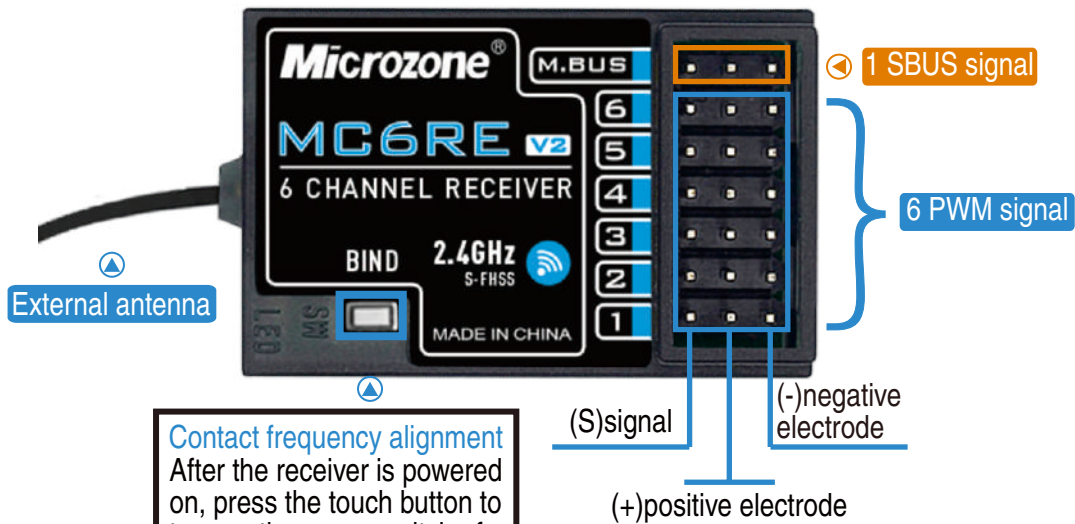

**Contact frequency alignment**  
After the receiver is powered on, press the touch button to turn on the power switch of the remote control, and the frequency matching is successful

### MC7RB-V2

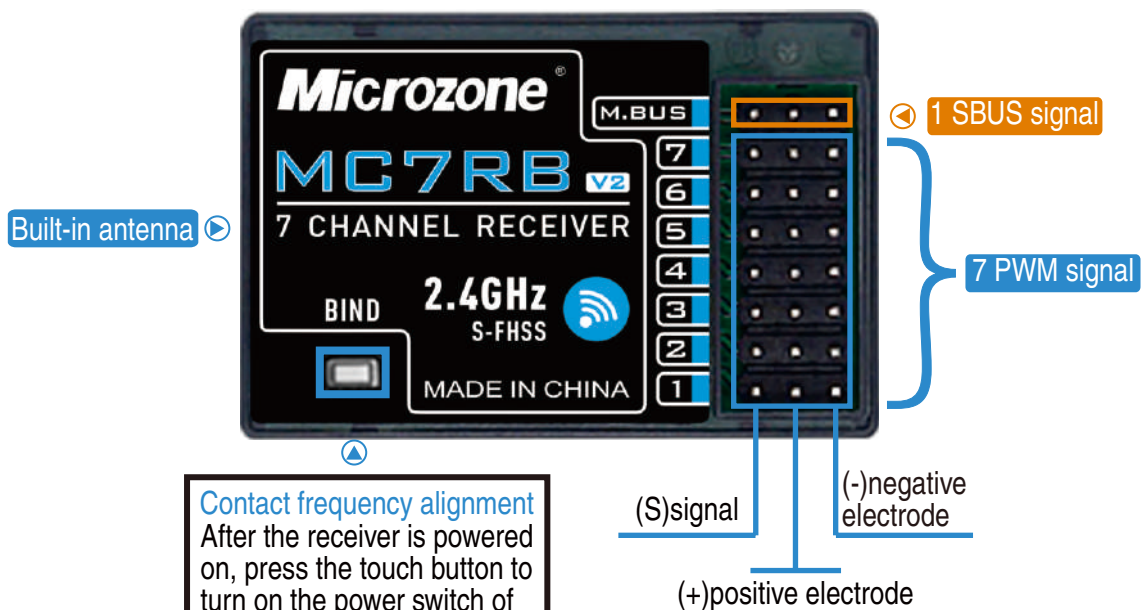

**Contact frequency alignment**  
After the receiver is powered on, press the touch button to turn on the power switch of the remote control, and the frequency matching is successful

## REMOTE CONTROL SPECIFICATIONS AND PARAMETERS

Model	6C-MINI
Color	Off-white
Number of channels	6
Applications	Fixed-wing/Car/Boat/Multi-axis/Lawn mower/ Intelligent agricultural machinery
Control range	>800m
Frequency range	2401 - 2478MHz
Rocker dynamic range	80%-120%
Fine-tuning method	Electronic fine-tuning
Transmitting power	≤100mw
Input voltage	DC4.5-9V
Modulation mode	FSK
Remote control power supply requirements	4 x 5 batteries or 2S lithium batteries
Low voltage alarm	Yes
Analog Picking (PPM)	Yes
Channel forward and reverse indication	Support
Runaway protection settings	Support
LED indication	Support
Support receivers	MC6RE-V2/MC7RB-V2/MC6RE/MC7RB/MC9002/E6R-E
Size	160*80*165mm
Weight	470g

## RECEIVER SPECIFICATIONS AND PARAMETERS

Model	MC6RE-V2	MC7RB-V2
Color	Teal transparent	Teal transparent
Applications	Fixed-wing/Car/Boat/Multi-axis	Fixed-wing/Car/Boat/Multi-axis
Channel output	6 PWM signals, 1 SBUS signal	7 PWM signals, 1 SBUS signal
Frequency range	2401MHz-2478MHz	2401MHz-2478MHz
Control range	>800m	>800m
Receiver supply voltage	DC:4.5-6V	DC4.5-6V
SBUS signal	Support	Support
Frequency pairing mode	Contact to frequency	Contact to frequency
Recovery performance	Fast signal recovery	Fast signal recovery
Runaway protection settings	Support	Support
Remote control support	6C-MINI/C7-MINI/8B-MINI/Classic-10	6C-MINI/C7-MINI/8B-MINI/Classic-10
Antenna type	External antenna	Built-in antenna
Antenna length	110mm	/
Size	37*23*13 (mm)	42*30*13 (mm)
Weight	7g	7g

## DETAILED DESCRIPTION

### Power supply:

DC4-8.4V, can be installed into the battery compartment using four No. 5 batteries, as shown in the following figure,

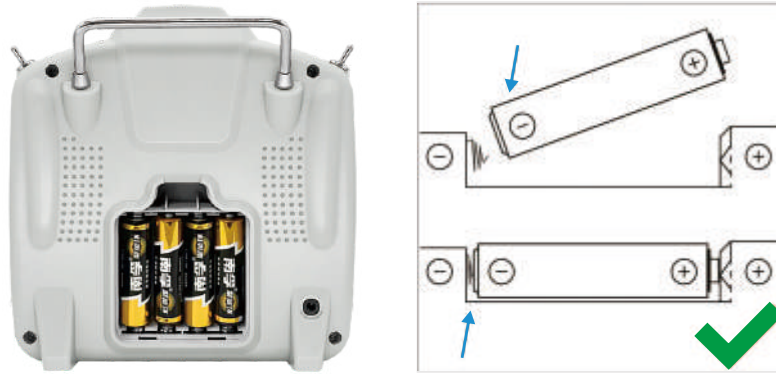

Alternatively, insert a 2S lithium battery into the battery compartment socket, as shown in the following figure,

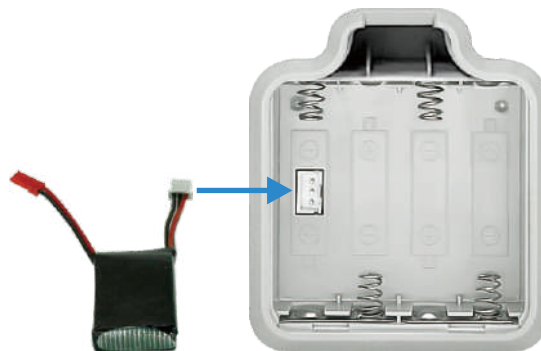

You can also use an external power supply to connect to the DC power socket on the right side of the remote control, as shown in the following figure, **When using an external power supply, please Remove the battery from the remote control battery compartment first.**



This DC port is not a charging port, Cannot charge, only available External connection to simulator teaching Power usage This DC port is not a charging port, Cannot charge, only available External connection to simulator teaching Power usage

**First use:**

When unpacking for the first time, please compare the frequency between the transmitter and receiver. After successful frequency comparison, the transmitter and receiver will receive Conduct short distance testing on the machine, holding the transmitter 10 to 15 meters away from the receiver, and shaking the transmitter Rocker to observe if the model is controlled by the transmitter. If controlled, it indicates that the transmitter and receiver are working properly.

**Frequency pairing:**

After the remote control is turned off and the receiver is powered on, press the frequency control button on the receiver, and the indicator light will flash quickly, the receiver will enter the frequency control mode, as shown in the following figure, then, turn on the remote control, and the receiver indicator light will turn on, the receiver will receive the signal normally.

**Taking MC6RE-V2 as an example**





## FUNCTION SETTINGS

### Channel Reverse:

Press any key (AIL, ELE, THR, RUD) for more than 1 second to switch direction, and the direction indicator light will light up as positive. When the indicator light is on, it indicates a reverse direction, as shown in the following figure.

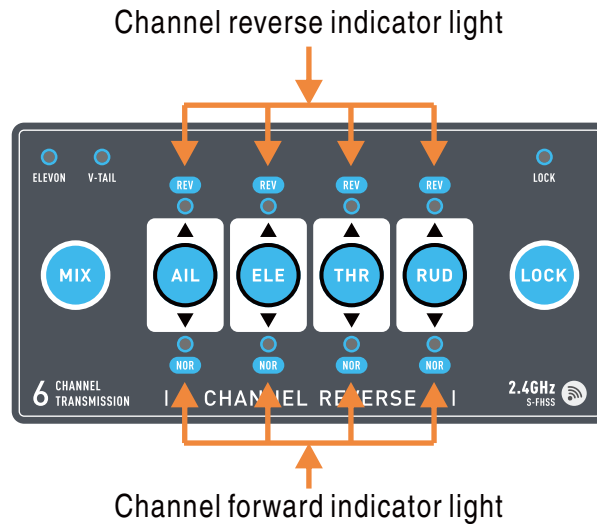

For example, on channel 1, when the reverse indicator goes to the lower side, the servo swings from left to right by turning the lever from left to right (Fig. 1), and when the reverse indicator goes to the upper side, the servo swings from right to left by turning the lever from left to right (Fig. 2).

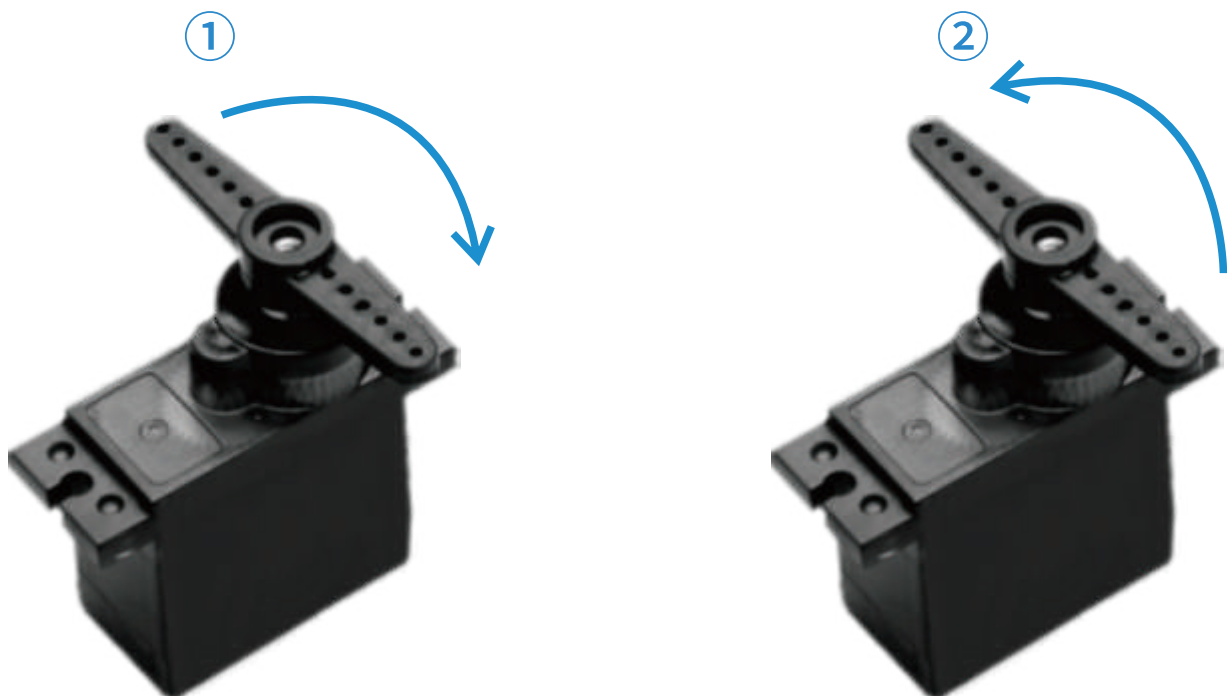

**Fine adjustment switch:**

The lower left trimming switch corresponds to channel 4, and the right trimming switch corresponds to channel 1; Upper left fine adjustment switch, left mode Corresponds to channel 3, and the right arrow mode corresponds to channel 2; Upper right fine adjustment switch, left mode corresponds to channel 2, right mode Equation corresponds to channel 3; As shown in the following figure.

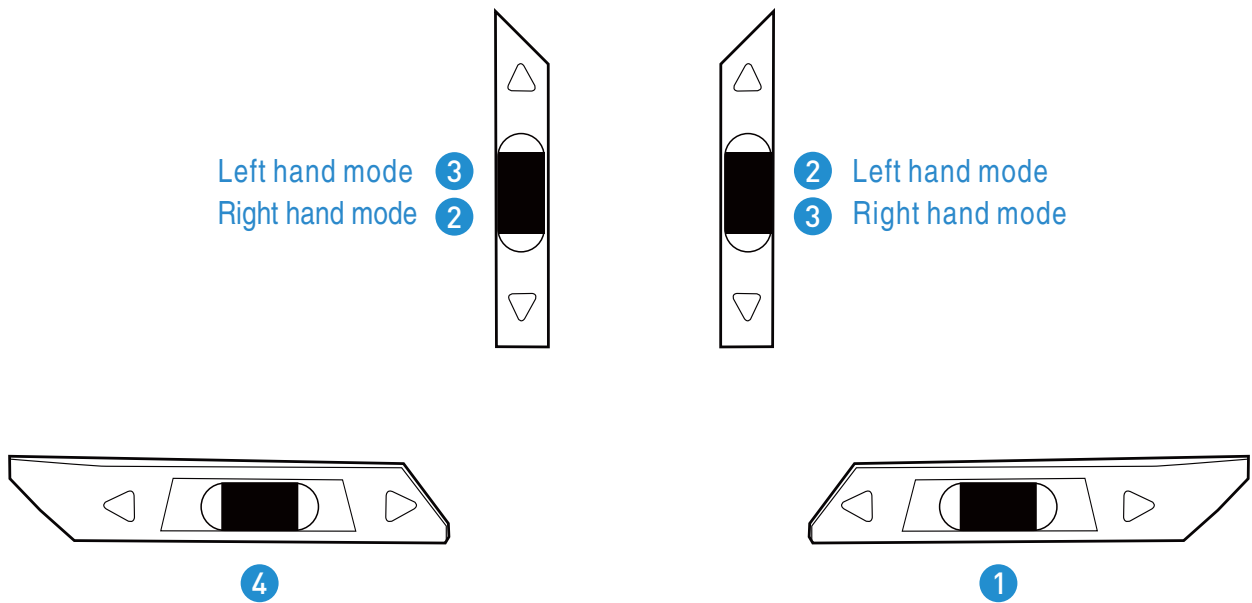

**Mixed control:**

After turning on the machine, press the (MIX) key for 3 seconds to switch to mixed control mode, The left light of the mixed control light is on for 1/2 mixed control, and the right light is on for 2/4 mixed control, As shown in the following figure, two lights off indicate no mixed control.

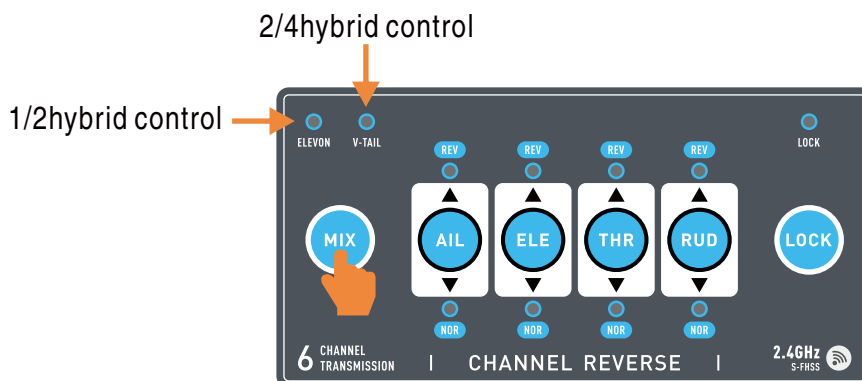

### Left and right hand switching:

Press and hold the (AIL+ELE) button before turning on the computer, switch between left and right hands; Left joystick up and down control channel in left hand mode 3; In right-hand mode, the right joystick controls channel 3 up and down; As shown in the following figure.

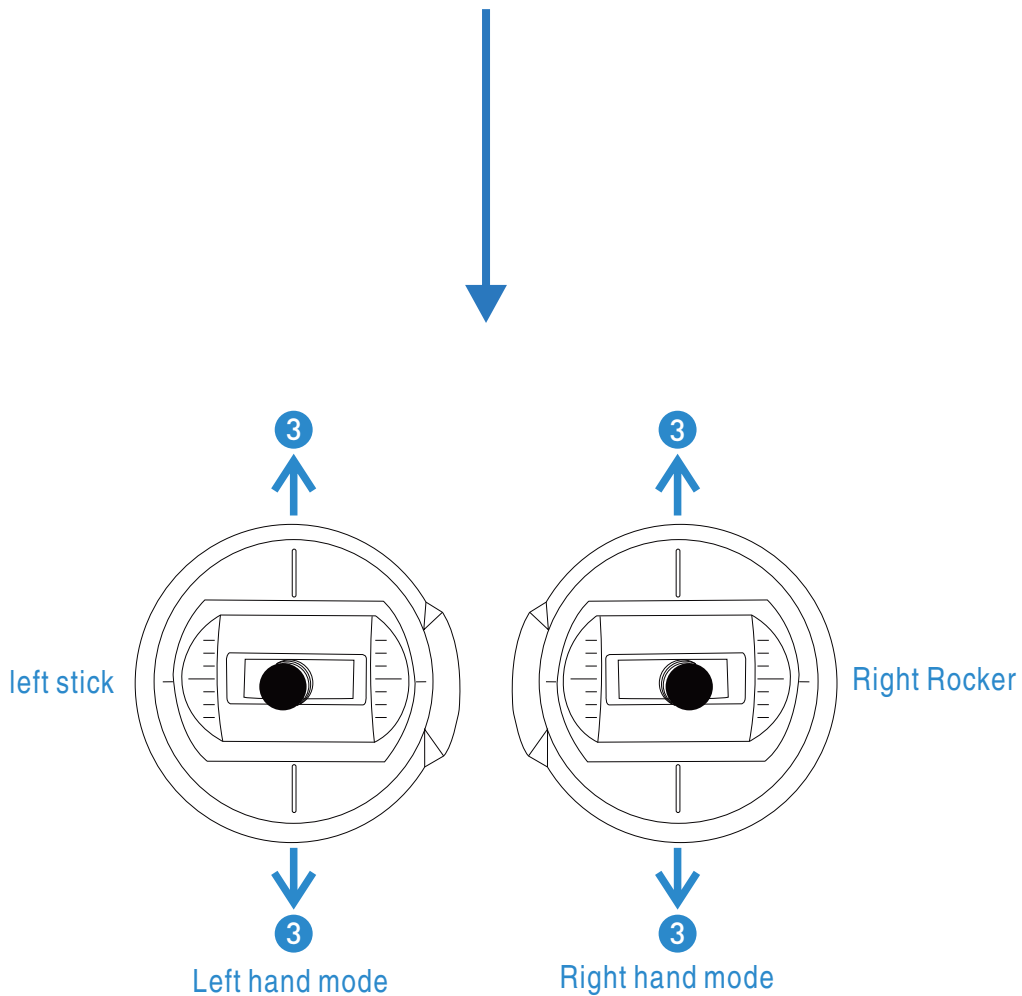
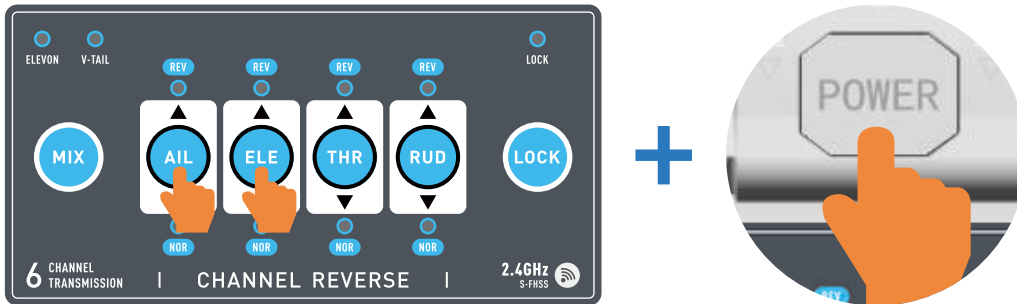

### D/R switch:

The large and small rudder Switching switch, the large rudder signal output is 100%, i.e., 1000-2000, and the small rudder output is 50%, i.e. 1250-1750.

### Keyboard Lock:

After turning on the machine, press the (LOCK) key for 3 seconds to lock it, After locking, the lock light will light up, and the fine adjustment/mixed control/reverse key is not available.

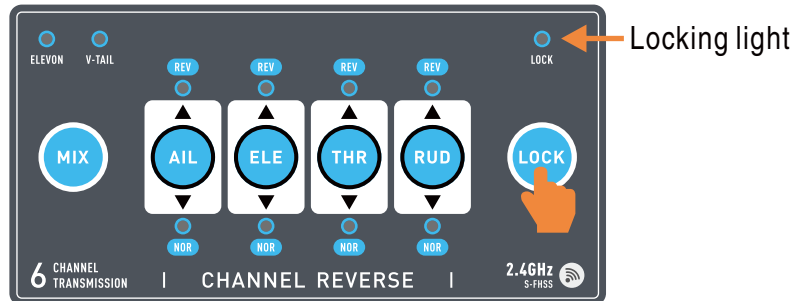

### Loss of control protection settings:

After turning on the computer, press the (AIL+RUD) key to send the runaway protection value, as shown in the following figure. When the receiver loses contact with the remote control, The value output by the receiver.

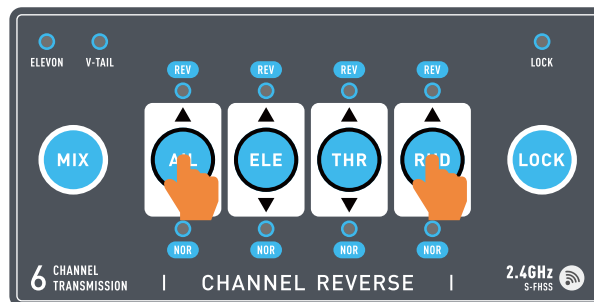

### Default runaway protection and customized runaway protection switching:

Factory default runaway protection value, that is, the third channel runaway protection value of 900, other channels 1500; long press the frequency pair button on the receiver for more than 15 seconds, the receiver indicator light flashes, can switch to user-defined runaway protection.

### Taking MC6RE-V2 as an example



### RF switching:

After turning on, press the (ELE+RUD) key to switch compatibility mode, as shown in the following figure, The default mode is 6C mini mode, and after switching, it is standard 6C mode.

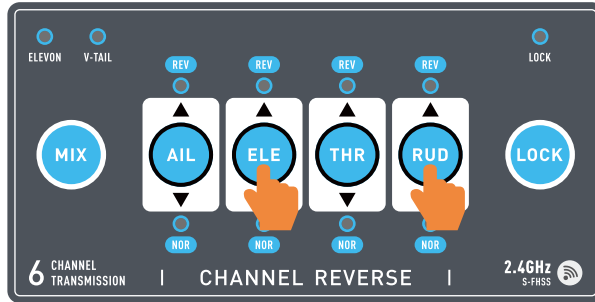

### Travel settings:

After turning on the machine, press the (ELE+THR) key to enter the settings (Fig.1), and turn the corresponding channel's fine adjustment switch (Fig.3) to increase the travel amount and press the (ELE+THR) key to exit the setup (Fig.2). Alternatively, reduce the travel amount and press the (ELE+THR) key to exit the setup (Fig.2).

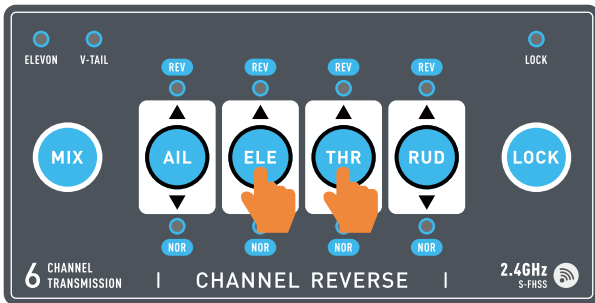

①

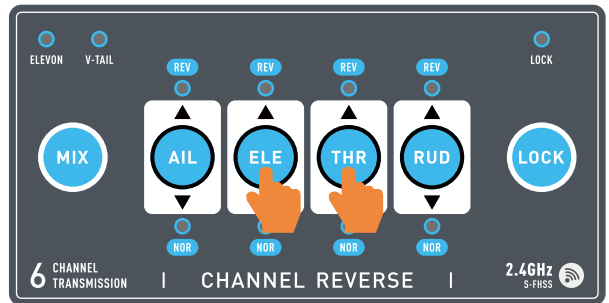

②

Left hand mode ③  
Right hand mode ②

③  
②



Left hand mode ②  
Right hand mode ③

②  
③



③

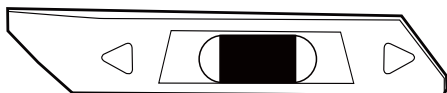

④

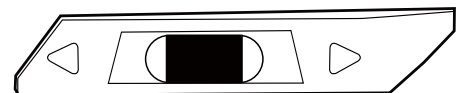

①

### SW function selection:

After turning on, press the (THR+RUD) key to switch the SW key function, as shown in the following figure;

**Travel volume switching:** When the function is turned on, the customized travel volume is output, and when turned off, it is restored;

**Channel 2 lock:** When opened, channel 2 locks the current value, After returning to the center, it pulls up one gear and down one gear, with 5 in each direction Gears.

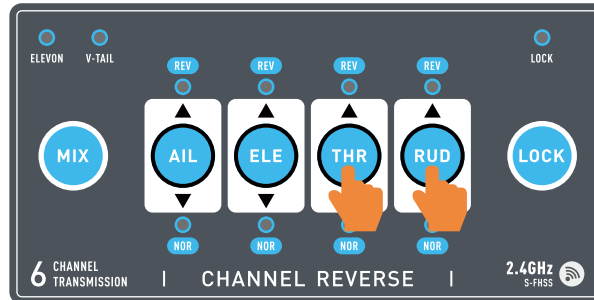

### Low pressure alarm:

Alarm for 4 dry batteries below 4V, and alarm for 2S lithium batteries below 7V.

### Restore factory settings:

After turning on the computer, press the (MIX+AIL) key to reset, as shown in the following figure, All settings except for the joystick calibration values are restored.

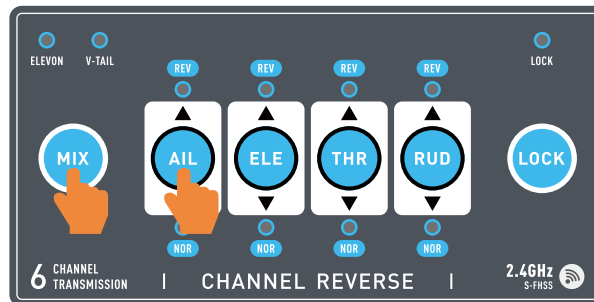

### No action shutdown:

In a non speed locked state, the remote control will automatically shut down after 15 minutes of inactivity, and will not automatically shut down when in a speed locked state Power off.

### Suggestions for safe shutdown:

To ensure the safety of the aircraft model and oneself, after the aircraft model motor stops running, first turn off the power supply of the model, and then turn it off again Turn off the transmitter power.

### Rocker calibration method:

When the transmitter is turned off, press and hold the (AIL+THR) key with both fingers and then press the power button to enter calibration. Below diagram;

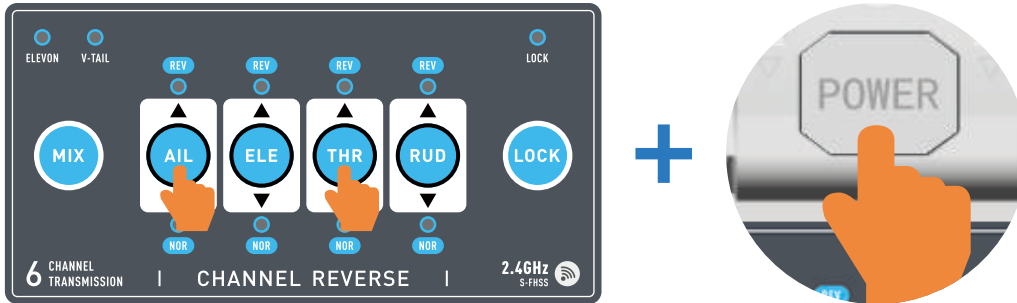

At this time, the power light and the mode light appear alternately flashing, and accompanied by dropping sound,

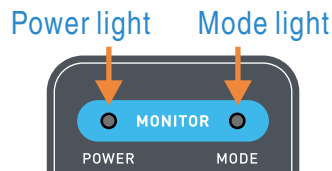

Swing the two rocker rods to the maximum amplitude, as shown in the following figure,

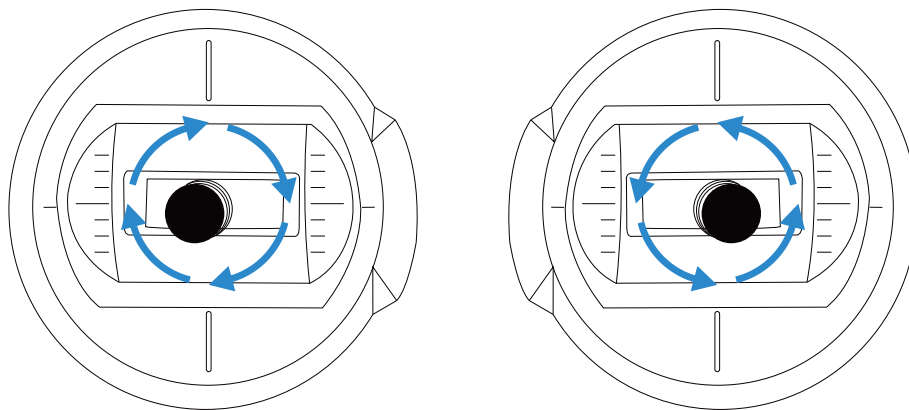

Then the two rocker rods are centered, as shown in the following figure,

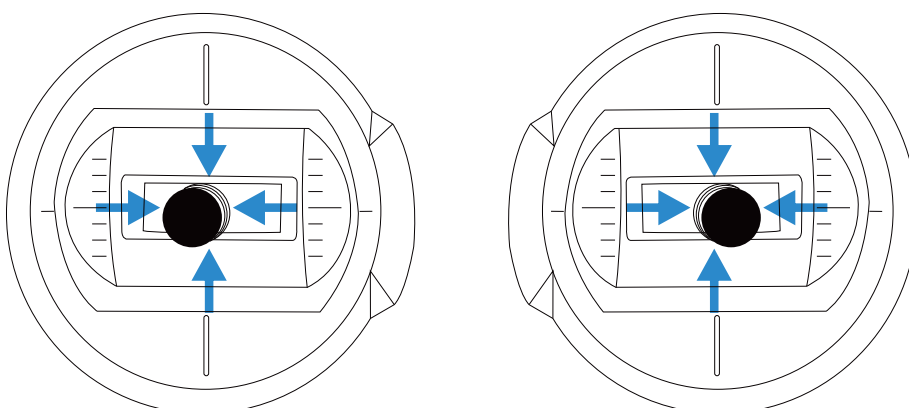

After the two joysticks are centered, rotate the D/R switch to complete calibration. At this time, the power light and mode light are on, and the joysticks are calibrated Complete.



**PPM simulator signal:**

The PPM signal has one frame of data every 20ms, starting from the low frequency, and the time from the first rising edge to the second rising edge is the channel 1 data, the time from the second rising edge to the third rising edge is the channel 2 data, and so on, The first rising edge to the second rising edge is the channel 1 data, the second rising edge to the third rising edge is the channel 2 data, and so on, as shown in the figure below, The following diagram shows.

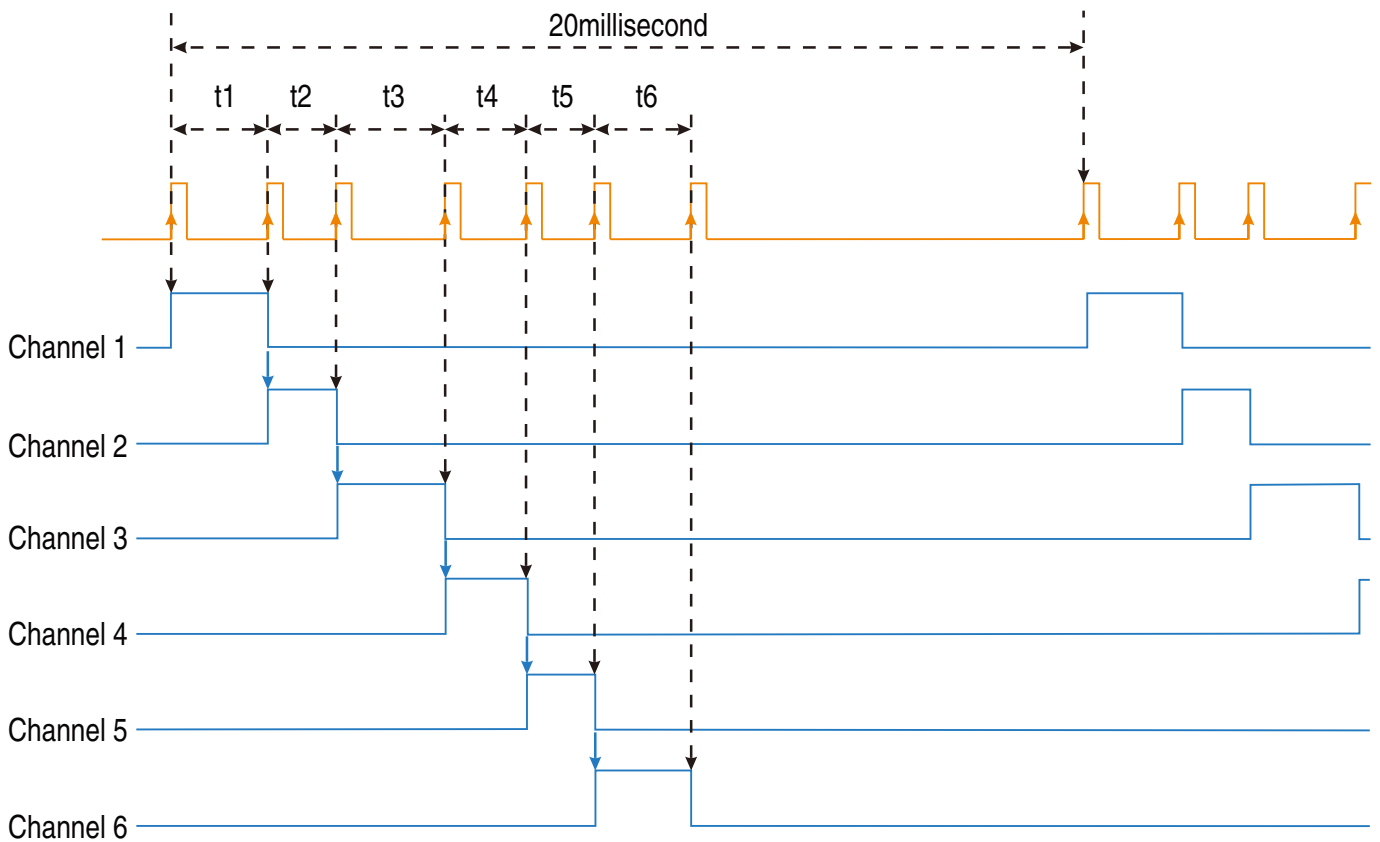



## STANDARD CONFIGURATION LIST

Packaging box \* 1, remote control \* 1, receiver \* 1;  
Standard receiver: MC6RE-V2/MC7RB-V2;  
Compatible receivers: MC6RE, E6R-E, MC7RB, MC9002.

## MATTERS NEEDING ATTENTION

**Before starting to use the remote control, carefully read the following precautions!**

1. This product is not a toy and is not suitable for children under the age of 12, Adults should keep this product out of reach of children and keep it out of reach of children Be careful when operating this product in the field.
2. Please do not use it in harsh weather conditions such as evenings, thunderstorms, snows, low energy levels, etc.
3. Do not use the remote control in snowy or watery places, if rainwater enters the remote control, the circuit will be short-circuited and cannot be used.
4. Signal interference may cause the remote control to go out of control, places where interference affects more than others are as follows:
  - A. Near the mobile phone signal transmission tower
  - B. Near high-voltage power lines and communication broadcasting antennas
  - C. Near the Military Radar Launch Tower
  - D. The complexity of wireless communication and the commercial path of mobile activities
  - E. Navigation domain
5. Please do not use this product after feeling tired, uncomfortable, drunk, or excited about drugs, otherwise it will cause serious injury to oneself or others The value of is.
6. The 2.4G line band is completely different from the low-frequency line radio band previously used, Please ensure that the model product is within your line of sight when using it Obstacles inside can block the signal from the power line, causing the remote control and model to lose control.
7. Before using it, it is necessary to ensure that the remote control and model are installed correctly, and that all steering gear actions and controls are in the same direction, otherwise it may cause damage to the model Severe damage to the engine.
8. When the remote control distance continues to be too far, there is a possibility of losing control, Please shorten the control distance appropriately; The battery voltage of the remote control is insufficient, transmitting The signal from the machine can cause loss of control; So when the remote control "POWER" flashes and there is an alarm, please replace the battery as soon as possible.
9. When stopping the remote control, be sure to cut off the power supply of the receiver and then turn off the remote control; If the power to the remote control is turned off first, the receiver will still be on Operation may cause the model to lose control or the engine to continue working, leading to serious accidents.
10. Improper use of the remote control may cause serious injury or even death to the operator or others; To ensure the safety of you, others, and equipment, please be careful Read this guide and follow the instructions.
11. The remote control and receiver required for our company's 2.4G wireless transmission system are used in pairs, while other company products cannot be connected to our company's products The product is of great value.